

ecostrad

INSTRUCTION MANUAL

Ecostrad Artis iQ Electric Panel Heater

INSTALLATION MANUAL



PLEASE READ AND SAVE THESE INSTRUCTIONS



Symbols



Warning

This symbol indicates a hazard with an average risk level which, if not avoided, could result in serious injury or death.



Warning of electrical voltage

This symbol indicates danger to the life and health of persons due to electrical voltage.



Do not cover

This symbol located on the device indicates that it is prohibited to place objects (such as towels, clothes etc.) above or directly in front of the device. To avoid overheating and fire hazards, the device must not be covered.



Hot surface

This symbol located on the device indicates that its surfaces are hot during and immediately after operation. Hot surfaces should not be touched: danger of burns.



Do not spray

This symbol located on the device indicates that it is prohibited to spray the device.



Observe instructions in manual

This symbol located on the device indicates that instructions in the operating manual must be observed when installing and using the device.

Contents

1	About the Product	2
2	Warnings & Precautions	3
3	Installation	6
3-1	Components	6
3-2	Wall mounting	7
3-3	Mounting on feet	8
4	Cleaning & Maintenance	9
5	Warranty	10
6	Disposal	11

1 | About the Product

This manual describes the **Ecostrad Artis iQ Electric Panel Heater** and details how to install and use the product. It is important to thoroughly review this manual before using the product.

For **technical advice** or help concerning the Ecostrad Artis iQ Electric Panel Heater, contact the retail establishment or distributor from which the product was purchased.

Heat Performance

The Ecostrad Artis iQ is designed to heat by passing air over an aluminium heating element in a process called convection. This highly responsive method of heat transfer will begin warming the air within minutes, ensuring a room is never cold for long. This type of heat is brilliant for supplementary warmth, hard-to-heat areas, or rooms not in frequent use.

In rooms with high ceilings, this heater may take slightly longer to warm the room, as the hot air may collect first in the high points of the room. For best results, always ensure precautions are taken to avoid heat loss, such as closing doors and blocking draughts.

Installation

This section of the manual covers the installation of the Ecostrad Artis iQ for installers. For information on how to set up and use the Ecostrad Artis iQ control panel, please see the User Guide.

2 | Warnings & Precautions

Read this manual carefully before using or installing the heater. Always store the manual in the immediate vicinity of the heater or its site of use.

Read all safety warnings and all instructions.

The heater should only be used according to the instructions in this manual. Failure to follow the warnings and instructions may result in electric shock, fire, serious injury, or all of the above. Save all warnings and instructions for future reference.



Warning

Children of less than 3 years should be kept away unless continuously supervised. Children aged from 3 years and less than 8 years shall only switch on/off the appliance provided that it has been placed or installed in its intended normal operating position and they have been given supervision or instruction concerning use of the appliance in a safe way and understand the hazards involved. Children aged from 3 years and less than 8 years shall not plug in, regulate, or clean the appliance, or perform maintenance.



Warning

This appliance can be used by children aged from 8 years and above and persons with reduced physical, sensory or mental capabilities or lack of experience and knowledge if they have been given supervision or instruction concerning the use of the appliance in a safe way and understand the hazards involved. Children shall not play with the appliance. Cleaning and user maintenance shall not be made by children without supervision.



Warning

Do not use the device in enclosed spaces if persons are present who cannot leave the room independently and are not under constant supervision.



Warning

To avoid overheating and risk of fire, do not cover the heater. Covering the heater for extended periods will activate the safety fuse, permanently disabling the heater.



Warning

In order to avoid a hazard due to inadvertent re-setting of the thermal cut-out, this appliance must not be supplied through an external switching device, such as a timer, or connected to a circuit that is regularly switched on and off by the utility.





Warning



Some parts of this product can become very hot and cause burns. Do not touch the surface when in operation. Do not install close to curtains or other combustible materials. Particular attention should be given where children and vulnerable adults are present.

- Keep the power cable away from all hot parts of the appliance.
- Do not use the heater with the power cable wound up. This can cause a dangerous build up of heat. Do not wind the cable around the appliance as this may cause weakening and splitting of the insulation. The power cable should be fully unwound and removed from any storage areas before use.
- Do not use the device if you detect damage to the mains plug or power cable. If the supply cord is damaged, it must be replaced by the manufacturer, its service agent or similarly qualified persons to avoid a hazard.
- All repairs and servicing must be carried out by a qualified person. To avoid danger any repairs must be completed by the manufacturer, a service agent of the manufacturer or a similarly qualified person.
- Make sure that the voltage indicated on the rating plate for this appliance corresponds to your power outlet.
- Check for transportation damage and make sure all parts are complete after the appliance is unpacked. Do not use if any parts are missing or damaged.
- Do not connect the product to the power supply until fully assembled and adjusted.
- It is recommended to plug the device directly into a wall socket. Use of extension leads is not recommended because many models do not support high-powered appliances. Make sure any extension lead used can safely support the power requirements of the product.
- The power cable should not be positioned under the carpet or items of furniture. Do not run the cable where it will be a trip hazard.
- Do not use this device in the immediate surroundings of a bath, shower, swimming pool or any other water container. Risk of electric shock. This product is not suitable for bathroom use.
- The device must be placed where the switches and controllers cannot be touched by a person in a bathtub or shower.
- Do not use the device with wet or damp hands.
- No part of the appliance should be submersed in any type of liquid.
- Cleaning should be carried out using a damp cloth only. No abrasive chemicals or materials should be used.
- Never insert fingers or other objects or body parts into the device. Risk of electric shock or injury.
- The device must not be located immediately below an electrical socket outlet.



- Keep all objects at least 1m away from the front, side or back of the heater.
- The device must only be installed in an upright and fixed position on a smooth, stable, heat-resistant surface.
- The device is for indoor use only.
- Make sure the minimum safety distances from walls and objects stated in the installation instructions are observed at all times. This is very important to prevent damage to walls, furniture and soft furnishings and to prevent the product overheating. 
- Do not use the device in rooms where contact with flammable or potentially explosive materials like dust, gas or vapour cannot be avoided.
- Do not use in rooms or environments that have a corrosive atmosphere.
- Do not use in places where food, artwork, or delicate scientific objects are stored.
- Do not put the appliance on a bed or long, thick carpet. This can cause the air inlet or outlet to become clogged and constitutes a fire risk.
- Do not operate the device when wet. If the device gets wet during cleaning, allow it to dry out before using.
- Do not expose the device to water jets.
- Do not transport the device during operation. 
- Do not sit on the device.
- Before carrying out maintenance, care or repair work on the device, ensure the device is unplugged. Do not use the cable to tug the plug from the socket. Hold the plug and pull.
- Switch the device off and disconnect the power cable from the mains socket when the device is not in use.
- Allow the device to cool down before touching or transporting the device, or attempting maintenance work.

3 | Installation

3-1 | Components

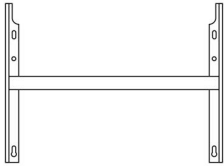
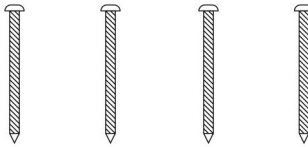
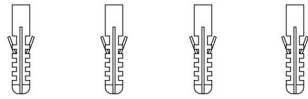
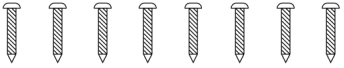
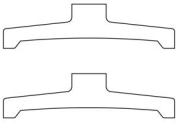
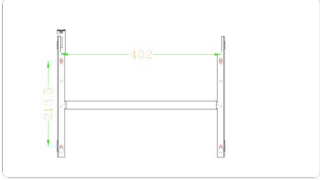

Before beginning installation, check that all fixings in **Table 1** are supplied. The heater should only be mounted with the manufacturer's fixings.

Table 1 | Fixings and components

Description		Quantity
H Bracket		1
Wall screws		4
Wall plugs		4
Feet Screws (if feet purchased separately)		8
Feet (if feet purchased separately)		2
Mounting template		1

3-1-1 | Tools required for wall mounting (not provided)

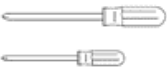
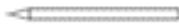
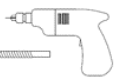
Table 2 | Fixings and components

Description		Description	
Screwdrivers		Pencil	
Drill and drill bit		Tape measure	

3-2 | Wall mounting

Note – The fixings supplied are designed for installation onto solid walls. Alternative fixings may be required if installing onto plasterboard or other non-standard wall types. It is the responsibility of the installer to evaluate the fitting location and determine if alternative fixings are required.

1. Decide the fitting location. The fixings supplied are suitable for use in solid masonry. For any other wall type you will need to source appropriate fixings. If fitting to a plasterboard wall, either fit directly to the wooden struts or otherwise strengthen the wall; do not fix through plasterboard alone.

Keep in mind the below minimum distances. The heater must be installed at least:

- a. 50cm from the top of the heater to shelves or ceiling.
- b. 15cm from the base of the heater to the ground.
- c. 1m from flammable materials and objects, e.g. curtains.

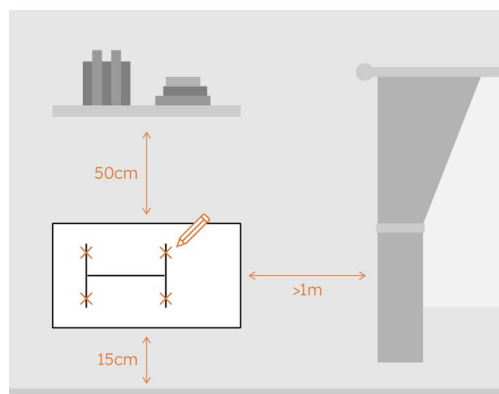
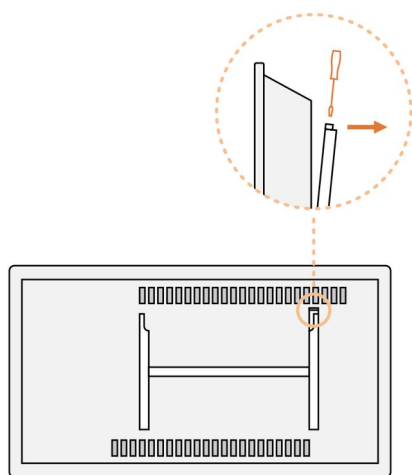

- 2) Insert a screwdriver into the slot in the top of the H-bracket and lever outwards to disconnect the H-bracket safety tab from the heater body. Push down to remove H-bracket from heater.

- 3) Hold the paper template up to the wall in the position decided in step 1 and mark the drilling locations with a pencil.

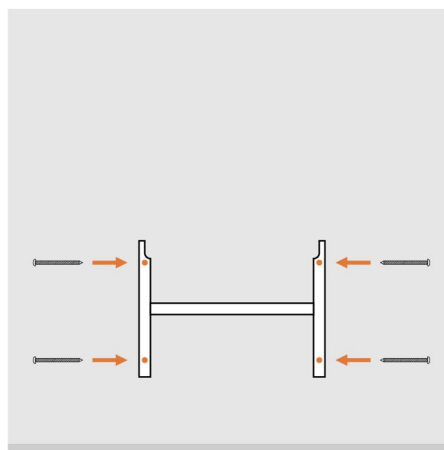
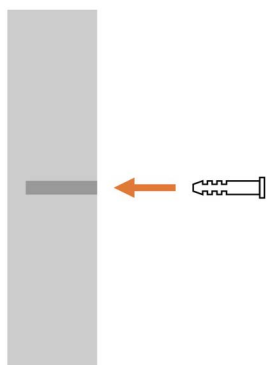

4) Drill the 4 screw holes in the marked positions and insert the wall plugs.

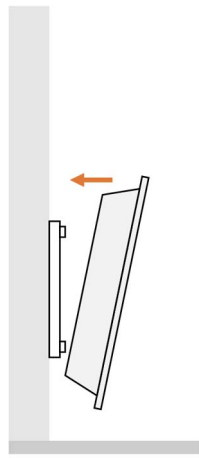

5) Line up the holes with the H-bracket and attach the H-bracket to the wall with the wall screws.

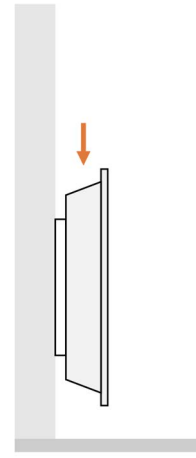

6) Carefully lift up the heater and click the H-bracket into the back panel of the heater.

7) Push the heater downwards to ensure a secure fit. Ensure the safety tab is firmly locked in place.

3-3 | Mounting on feet

The Artis iQ does not come with feet, but they can be purchased separately if a free-standing option is required. To mount the heater on the feet:

1. Carefully turn the product upside down. It is recommended to rest the heater on a soft, cushioned surface to do this, so as not to damage the glass.
2. Line up the feet with the screw holes and click into place.
3. Attach the feet to the heater body using the feet screws and a screwdriver.

4 | Cleaning & Maintenance

The heater should be cleaned regularly to ensure fault-free operation. The most common cause of overheating is the build-up of dust or fluff within the heater. Prevent this from happening by regularly unplugging the heater and dusting the vents and grille.

Always disconnect the appliance and allow it to cool completely before cleaning. Use a vacuum cleaner to remove dust from the grilles. Clean the outside of the unit with a damp cloth and then dry it with a dry cloth. Do not use abrasive or chemical cleaners as these will damage the finish over time. Never immerse the unit in water or let water drip into the unit. Risk of electric shock.



If the heater is going to be out of use for long periods, for example over summer, the best way to keep it clean and extend its lifespan is to put it into storage. Disconnect the appliance and allow it to cool completely before packing it in its original packaging and storing it in a dry and ventilated place. Do not place heavy items on top of the box during storage as this may damage the appliance.

5 | Warranty

The Ecostrad Artis iQ Electric Panel Heater carries a 1-year guarantee on the body, electronics and paintwork.

What does the warranty cover?

Within the stated period, starting from the date the customer receives their unit, Ecostrad guarantee to repair or replace the unit where a fault is due to defects in materials or manufacturing.

What does the warranty NOT cover?

The warranty does not cover any defect arising from damage, negligence, usage outside the product's intended purpose or fair wear and tear. The warranty is only valid when the unit has been used at the specified supply voltage, and in accordance with all conditions specified in this manual. The warranty will be void if the heater has been covered, tampered with or opened in any way, or if the ratings label has been removed.

The warranty does not cover failures and faults due to force majeure, accidental damage, mishandling, external impact, chemical agents or atmospheric phenomena, incorrect use of the device, the purchaser's faulty electrical installations, transporting the device or problems caused by the device being handled by persons not authorised by Ecostrad. If the unit has been hardwired, an invoice may be required to confirm the work was carried out by a qualified professional. Ecostrad cannot accept responsibility for damage, loss or injury caused by incorrect installation, maintenance, cleaning or covering the device.

How to claim

The warranty is a contract with the original purchaser and does not transfer if the unit is re-sold, gifted or inherited. Proof of purchase, including order number and order confirmation or invoice, will be required if a claim is made.

The warranty covers only the model of heater shown on the purchase invoice. The warranty covers the repair or replacement of the defective product only and Ecostrad shall have no liability for installation costs or consequential losses however incurred. The unit is sold as a DIY product; whilst hardwiring is permitted within the terms of the warranty – provided evidence can be produced that the work was performed by a qualified installer – no compensations will be offered for the installer's costs in the event of a claim.

Claims must be made with the establishment where the device was purchased. This warranty does not affect the customer's consumer rights.

6 | Disposal



In accordance with WEEE Directive 2012/19/EU, the icon with the crossed-out waste bin on electrical or electronic equipment stipulates that this equipment must not be disposed of with household waste at the end of its life. You will find collection points for free return of waste electrical and electronic equipment in your vicinity. The addresses can be obtained from your local authority.

The separate collection of waste electrical and electronic equipment enables the re-use, recycling and other forms of recovery of waste equipment, and prevents any negative effects for the environment or human health caused by the disposal of hazardous substances potentially contained in the equipment.

For queries, contact:

In the UK

Ecostrad Ltd.
Firecrest House
Lingerfield Business Park
Market Flat Lane
Knaresborough
North Yorkshire
HG5 9JA

In ROI

Ignition Heatco Ireland Limited
Unit 282
Block G
Blanchardstown Corporate Park 2
Dublin
Republic of Ireland
D15 R65X

<https://ecostrad.com/>

